

Print Area

CONTENTS

● UV Offset Printing Ink	01
● UV Flexo Printing Ink	02
● Fabric Ink	03
● Water Base Ink	04
● Soy Bean Offset Printing Ink.....	05
● Pantone Spot Color Series	07
● Metal Decorating Ink	08
● Screen Ink	09
● UV Drip off Varnish	09
● UV Varnish	10
● Auxiliary Ink	11
● Security Ink	12
● Security paper	17
● Printing Blanket	18
● Printing Chemical	20
● Hot Melt Adhseive	21
● Printing Material	22
● Printing Spare Part	24
● Air Filter / Double Wire	31

UV Offset Printing Ink

Generally used for paper printing.

310-UV

310-LED



UV Offset Printing Ink

Generally used for paper and film(PP,PE,PVC).



316-UV

316-LED



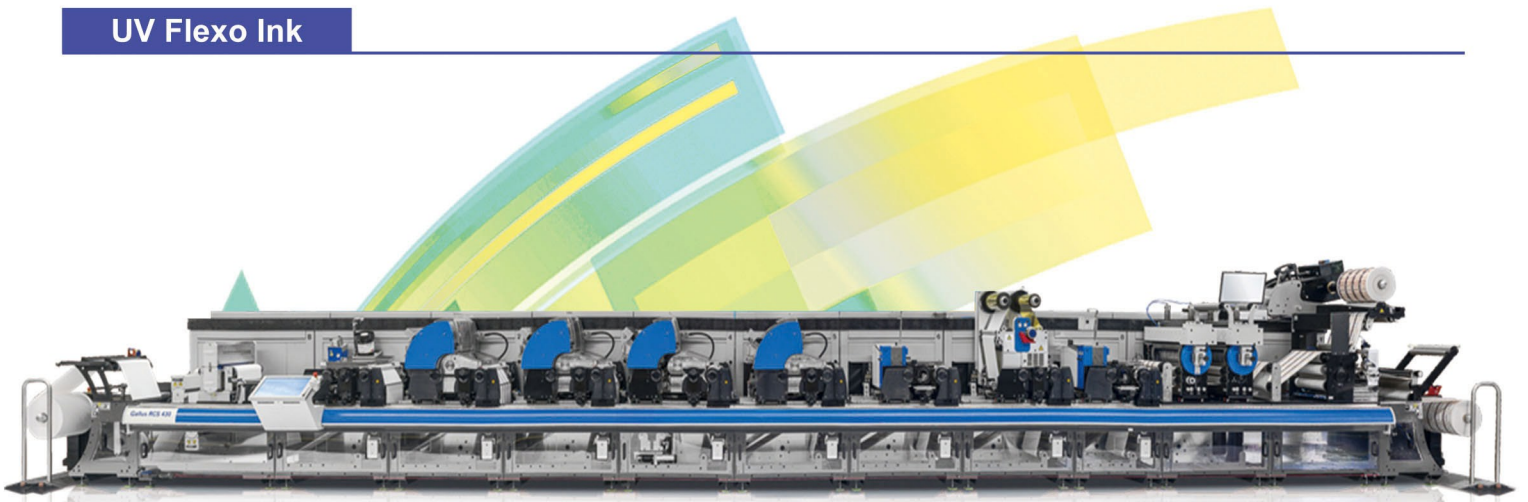

UV Flexo Ink

Stronger ink transfer performance, higher color strength, and better printing density, high-definition dots, text and solids are obtained when printing on high screen line.

Features

1. High color strength, 10-15% higher than ordinary ink.
2. Lower odor, suitable for odor-sensitive product packaging such as food cosmetics.
3. Good curing performance, suitable for high speed printing.
4. Suitable for various doctor blade systems.
5. Lower viscosity and more stable and consistent viscosity.
6. Excellent combination printing.
7. Excellent printability and dot reproduction.
8. Wide range of applicable materials, good adhesion to materials.
9. Less printing and absorption on paper materials.

Application range

1. In-membrane label 2. Wrapping tags 3. Various non-absorbent materials 4. Sticker
Notes: Hot stamping and thermal transfer embossing

New Packaging



Lid Design: The oil nozzle cap is designed to pour ink without leakage.



PANTONE SPOT COLOR SERIES



Fabric Ink

Technical Features

- ① Odourless
- ② High brightness
- ③ Excellent opacity
- ④ Perfect for flexographic printing
- ⑤ Good continuous printability
- ⑥ Washable after printed



Water Base Ink



PE Gravure Ink PET Gravure Ink



- **Application scope:**
Food bags, Snack bags
- **Printing method:**
Inner / Surface printing
- **Certification standards:**
ROHS,FDA,SGS

Matte Water-based Varnish



Feature:
The matte degree of this varnish can reach absolute zero, with good transparency, no whitening, good scratch resistance, waterproof and anti-whitening effect.

Water-based Touch Varnish



Application:
Paper, kraft paper, non-woven fabrics, BOPP film, PET plastic film, etc.

Temperature Sensitive Ink



Temperature Range:
The color-changing temperature range is 20-65 degrees Celsius.

Applicable:
PE,PP,PS and other plastic films

BOPP Flexo Ink



Application:
This is a flexographic water-based ink specially used for BOPP film printing.

Plastic Flexo Ink



Applicable :
This is a flexographic water-based ink used to print plastic woven bags.

Non-woven Water-based Ink



Application:
This is a flexo water-based ink specially used for non-woven printing.



Water-based ink for paper cups



Applicable :
Specially used for printing disposable paper cups.



Carton Water-based Ink



Application:
This is a water-based ink specially used for carton printing.

YT-02 Ink — High Brightness

- High gloss and color density
- Quick dry, stability on printing press
- Rich layering, good reappearance of half-tones
- Water and rub resistance
- Low odor and non-skin irritation

Production Workshop



YT-03 Ink — Quick Drying

- High gloss and density of color
- Fast drying, stability on printing press rich layering, good reappearance
- Water and rub resistance conforming to the standards of EN71-3, RoHS
- Eco-friendly ink for offset printing, soy based ink

Ink on the Machine



YT-08 Ink — NON-VOC Pure Vegetable Ink

- **Environmental protection:** No heavy metal components, no solvent volatilization and drying, and Near zero emissions of VOCs.
- **Good friction resistance, Strong fluidity, Water resistance, Superior printing.**



YT-09 Ink — Eco-friendly Ink

- High gloss and color density
- Quick dry, stability on printing press
- Low odor and non-skin irritation
- Water and rub resistance
- Conforming to the standards of EN71-3, RoHS
- Rich layering, good reappearance of half-tones
- Matching color as customer request
- Excellent offset printing ink for offset printing



Food Wrapping Paper



Children's Book



A-1 Ink — Economic ink







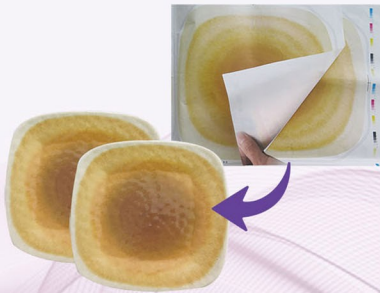





- High Gloss
- High Color Density and Quick Dry
- Water and Rub Resistance
- Economy

YT-06 Ink — Melamine Ink

- Heat and sunlight resistance
- Holding color and hard to bleeding color
- Higher density of color
- Brilliant on the thinner coatings
- Conforming to the stands of EN71-3, RoHS
- Low odor and non-irritation
- High-definition multiple printing stocks



Pantone Spot Color Series

	904 Reflex Blue		912 Purple
	905 Warm Red		913 Violet
	906 Orange 021C		914 Red 032C
	907 Green		915 Blue 072C
	908 Ultramarine Blue		916 Process Blue
	910 Rhodamine Red		917 Special Black
	911 Rubine Red		919 White
	925 Reflex Blue*(This ink will not change color.)		



Metal Decorating Ink

Two-piece Cans



Three-piece Cans



Printing method

- Offset Printing(Oven / UV Dry / UV LED Dry)

Features

- Strong adhesion to metal sheets
- Good solvent resistance
- Good Light resistance
- Good Baking resistance
- Good Cooking resistance



INK COLOR GUIDE

	ET Plate		W/C ET Plate	
Substrate				
Cyan			Purple	
Magenta			Violet	
Yellow			Process Blue	
Black			Reflex Blue	
021C Orange			Green	
Pantone Yellow			032 Red	
Yellow 012			Opaque White	
Rubin Red			Super Black	
Rhodamin Red			874C Gold	

Screen Printing Ink

Printing method: Screen printing (Normal / UV Dry)

Application

Suitable for ABS, acrylic plexiglass, KT board, PVC ,PC, PS, AS and other plastic injection molding of various transparent plastic sheets.

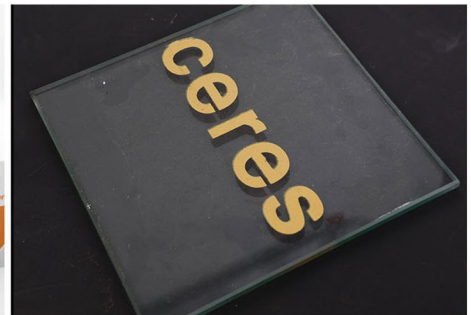

UV Drip off Varnish (The Best Partner)



Ceres 200
Primer



Ceres 100
Varnish

Features

- 1.Go directly hot stamping after printing.
- 2.Exquisit line 0.10mm perfect performance.
- 3.Lines interval could be controlled to a minimum 0.10mm.

• Low Odor,Good Flexibility.

• Reduce the production cost,earn more profits.

UV Varnish



YY-588 UV Varnish (Coated)



YY-688 UV Varnish (Not Coated)

Application

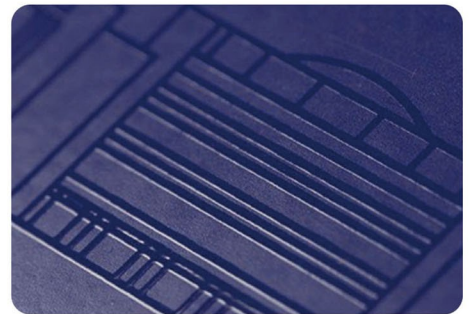
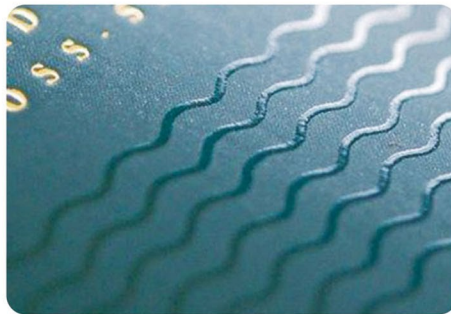

Production Workshop



Auxiliary Offset Ink

YT-500 Matt OP Varnish

- Excellent matt effect
- Fast drying
- High transparency



Packing: 2.5Kg/Can 6Cans/Carton

YT-660 Gloss OP Varnish

- Higher mirror surface effect and fast drying.
- High transparency and tenacity and not easy to turn yellow.



Packing: 2.5Kg/Can 6Cans/Carton

Description	Feature	Packaging	Picture
YT-300 Primer Coating for Paper	<ul style="list-style-type: none"> • Remedy the power dropping, wrinkle and other quality problem of the paper. • Improve printing quality 	2.5Kg/Can 6Cans/Carton	
YT-901 Clear Medium	<ul style="list-style-type: none"> • High transparency and gloss • Not easy to yellow 	2.5Kg/Can 6Cans/Carton	
902 JellyCompound	<ul style="list-style-type: none"> • Reduce the viscosity of the ink efficiently. • Transparent jelly condition. 	2Kg/Can 6Cans/Carton	
YT-903 Varnish	<ul style="list-style-type: none"> • Reduce the viscosity of the ink efficiently. • Promote the glosses and fast drying. 	4Kg/Can	

Optical Variable Ink

Printing method: Screen printing / Flexo printing

Applications: Paper, cloth, metal, glass, ceramics, plastic and so on. Such as: currency, passport, card, tobacco, alcohol, drugs, cosmetics labels, packaging and other printed matter with high anti-counterfeiting requirements.



UV Invisible Ink

Printing method: Screen printing, offset printing, flexo printing and inkjet printer

Applications: Mainly used in currency, bills, cards, cosmetics labels, packaging, etc.

Longwave(365) Red Shortwave(265) Yellow



Temperature Sensitive Ink

Printing method: Screen printing / Flexo printing

Suitable material: Paper, cloth, plastic, metal

(Remark: Temperature sensitive inks are reversible and irreversible)

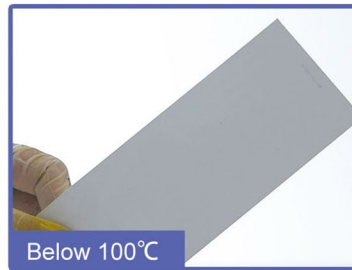

Fragrance Ink

Printing method: Screen printing / Offset printing

Application: Greeting cards, postcards, children's books, tissue, etc.



Scratch Off Ink



Printing method: Screen printing / Flexo printing

Applications: Mainly used for confidential documents, code security signs, lottery tickets, lottery cards and so on.

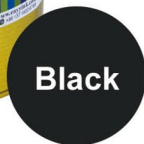

Photochromic Ink

Printing method: Screen printing

Suitable material: Metal, cloth, paper

Specification: The ink in the dark light display for a specific color, after sunlight the ink into another color, in the dark light to restore the original color.



Outdoor

Indoor



Indoor



Outdoor

Glow In Dark Ink

Printing method: Screen printing

Application: Electrical switch, warning signal, crafts, clothing, paper, etc



In the Daylight



In the Dark

Magnetic Ink

Printing method: Screen printing/offset printing

Application: Mainly used in ticket, printing, bank passbook, ID card and other magnetic card printing security.



Water Sensitive Ink

Printing method: Screen printing

Applicable material: Water cloth, umbrella, children's book, sticker label.

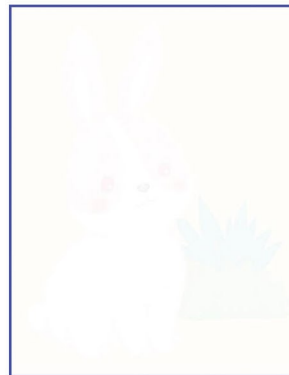

Before the water



After the water

Water Diffusion Ink

Printing method: Screen printing

Application: Water Diffusion Ink is irreversible. Generally used for water detection or authenticity detection of electronic products.



Before the water



After the water

Watermark Ink

Printing method: Screen printing and offset printing

Applications: Mainly used for books, manuals, warranty cards, certificates, invoices security.



White



Black

Conductive Ink

Printing method: Screen printing

Application: Used for printing circuits, electrodes, electroplating substrate, keyboard contacts, printing resistors and other materials

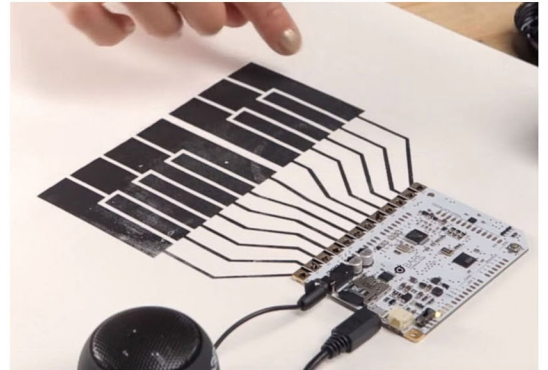

Laser Ink

Features: Excellent adhesion, covering power, good wear resistance, full and beautiful color.



Reflective Ink

Features: Good scratch resistance, high hiding power and good adhesion



Mirror Ink

Application: Mirror ink is printed on transparent plastic sheets and glass, such as PC, PET, PVC and PMMA.



We could produce all kinds of security inks, such as UV Invisible Ink, Optical Variable Ink, Temperature Sensitive Ink, Photochromic Ink, Water Sensitive Ink, Watermark Ink, Water Diffusion Ink etc.

More security ink, please feel free to consult us!

Security paper

It is mainly used in the government offices, certificates, lottery, bills, real estate contract, education department, famous brand food and clothing, medicine, cosmetics, tobacco, tea, wine, publishing industry, and so on. The security features with high-anti-counterfeiting, safety and strong confidentiality.

Watermark Paper



Color Fiber Paper

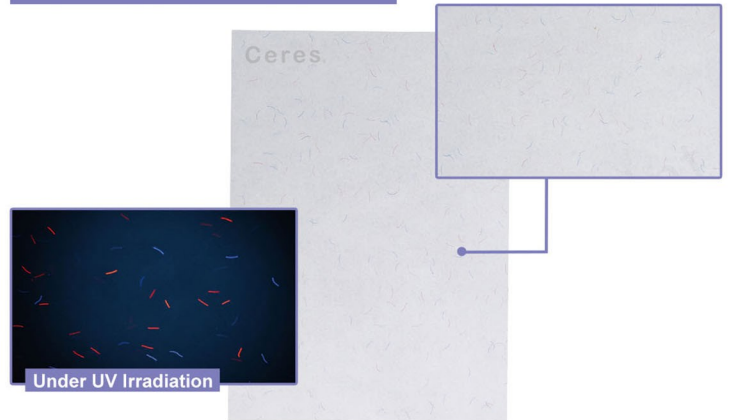

Safety Thread Paper



Welcome to customize various effects of the security line paper!



Offset Rubber Blanket

① Ceres Blanket YY-399A (Thickness:1.95mm)

- High quality
- Excellent durability with new compressible layer and surface.



② Ceres Blanket YY-386A
Thickness:1.95mm



③ Ceres Blanket YY-355A
Thickness:1.95mm



UV Rubber Blanket

④ Ceres Blanket YY-362A
Thickness:0.95mm/1.68mm/1.95mm



⑤ Ceres Blanket YY-389A
Thickness:1.95mm



Rotary Rubber Blanket

⑥ Ceres Blanket YY-386A
Thickness:1.68mm

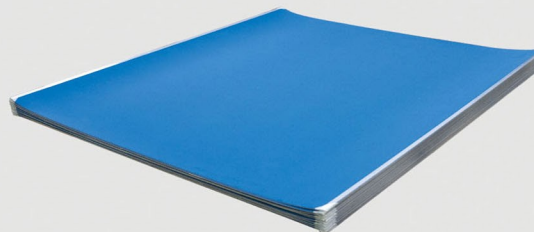

⑦ Self-Adhesive Rubber Blanket

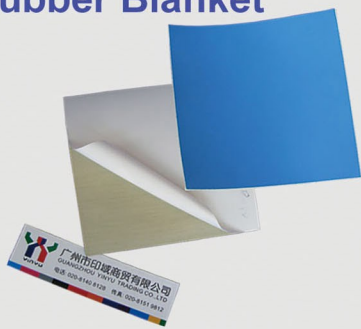

Thickness:0.95mm/1.05mm/1.95mm

⑧ Money Printing Blanket



Thickness:0.5mm

⑨ Underpacking Blanket



Thickness:0.65mm/1.0mm



RUBBER BLANKET

Small Thickness Tolerance

Durability

Good dot sharpness

Stable Quality

BLANKET FACTORY



Customize different aluminum bars for different model machine.

- We could offer you all kinds of printing blankets, such as UV blanket, self-adhesive blanket, high-speed sheet-fed offset blanket, web printing blanket, billprinting blanket.
- Thickness: 0.95mm, 1.68mm, 1.95mm.

Printing Chemical



YY-363 Plate Cleaner



YY-369UV Plate Cleaner



Blanket Reductant



YY-338 Gum Solution



Super Clean



Lube Clean



Quick Print



Quick Drier



Fountain Solution



Alcofree Fountain Solution YF-100



Roller Wash



UV Roller Wash



Developer

Developer Powder



Conditioning Paste

Image Remover Pen



Ceres Spray Powder

Hot Melt Adhesive for Bookbinding



YY-1102



YY-1108



YY-1109



YY-1112



Ceres Plate Series (Special specifications can be customized.)



PS Plate / CTP Plate / CTCP Plate / Free Chemical CTP Plate



A1/A2/A3
TOYOBO Printight Photo-sensitive Nylon Printing Plate



0.1mm/0.2mm
Germany Lohmann
Double Side Tape



ARFA HNU Film



ARFA HS Film

Specification

- Membrane: Outer/Inner
- Diameter: 50.8mm-71.9mm
- Flange: Hard/Soft
- The highest density is 5.0: the exposure and rinsing latitude is large, the resolution is high, and the dots and lines are clear and sharp.
- High contrast, red light, suitable for image recording of krypton laser sources.



Perfect Perf

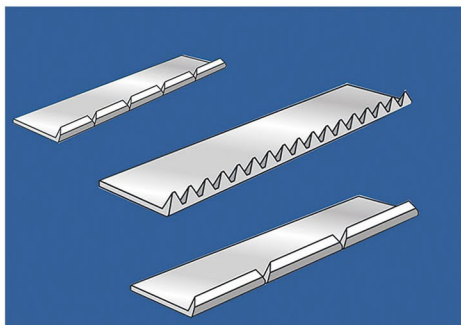
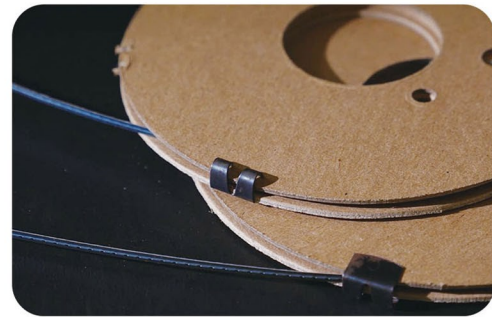
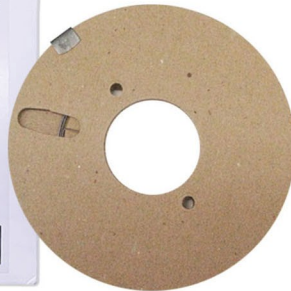

PERF	16 TPI	12 TPI	8 TPI	6 TPI
Description	Item #	Item #	Item #	Item #
Card 10 ft (3 m)	T-504	T-506	T-508	T-510
Card 20 ft (6 m)	T-505	T-507	T-509	T-511
Paper 10 ft (3 m)	T-604	T-606	T-608	T-610
Paper 20 ft (6 m)	T-605	T-607	T-609	T-611

MICRO-PERF	30 TPI	40 TPI	50 TPI	SNAP	4 TPI	3 TPI
Description	Item #	Item #	Item #	Description	Item #	Item #
Paper 10 ft (3 m)	T-619	T-620	T-621	Card 10 ft (3 m)	T-512	T-514
Paper 20 ft (6 m)	T-616	T-617	T-618	Card 20 ft (6 m)	T-513	T-515
				Paper 10 ft (3 m)	T-612	T-614
				Paper 20 ft (6 m)	T-613	T-615

SLIT	SCORE
Description	Description
Card 10 ft (3 m)	Card 10 ft (3 m)
Card 20 ft (6 m)	Card 20 ft (6 m)
Paper 10 ft (3 m)	Card (round top) 20 ft (6 m)
Paper 20 ft (6 m)	Paper 10 ft (3 m)
	Paper 20 ft (6 m)



Cutting Sticks(PE/PVC/NYLON)
All the sizes could be customized.



Polar Cutting Sticks
(For different sizes)

Ceres Creasing Matrix

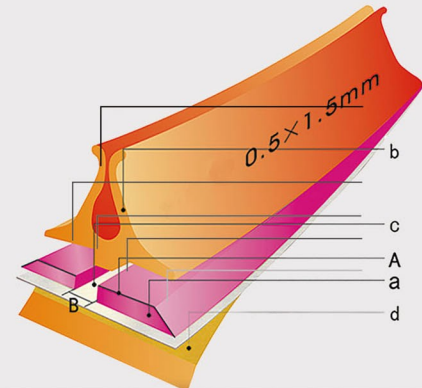

Creasing Matrix Size

0.3*0.8	0.4*0.8	0.5*0.8	0.6*1.5	0.7*1.5	0.8*2.0	1.0*2.7	1.2*3.0	Narrow 0.3*0.8	Narrow 0.5*0.8	Narrow 0.6*1.5	Narrow 0.7*1.6	Double slot 0.4*1.3*1.2	Back pressure line 2Pt0.3*0.6 1.5-1.9
0.3*1.0	0.4*1.0	0.5*1.0	0.6*1.6	0.7*1.7	0.8*2.3	1.0*3.0	1.2*3.5	Narrow 0.3*1.0	Narrow 0.5*1.0	Narrow 0.6*1.6	Narrow 0.7*1.7	Double slot 0.4*1.3*1.9	Back pressure line 2Pt0.3*0.6 2.3-2.7
0.3*1.2	0.4*1.2	0.5*1.2	0.6*1.7	0.7*1.9	0.8*2.5	1.0*3.2	1.2*4.0	Narrow 0.3*1.2	Narrow 0.5*1.2	Narrow 0.6*1.7	Narrow 0.7*2.1	Double slot 0.4*1.3*4.0	Back pressure line 2Pt0.3*0.6 1.9-2.3
0.3*1.3	0.4*1.3	0.5*1.3	0.6*1.9	0.7*2.1	0.8*2.7	1.0*3.5	1.2*4.5	Narrow 0.3*1.3	Narrow 0.5*1.3	Narrow 0.6*1.9	Narrow 0.7*2.3	Double slot 0.5*2.1*1.0	Back pressure line 3Pt0.3*0.6 2.7-3.2
0.3*1.4	0.4*1.4	0.5*1.4	0.6*2.0	0.7*2.3	0.8*3.0	1.0*4.0	1.2*5.0	Narrow 0.3*1.4	Narrow 0.5*1.4	Narrow 0.6*2.1	Narrow 0.7*2.5	Double slot 0.5*2.5*1.0	Back pressure line 3Pt0.3*0.6 2.3-2.7
0.3*1.5	0.4*1.5	0.5*1.5	0.6*2.1	0.7*2.5	0.8*3.2	1.0*4.5	1.2*6.0	Narrow 0.3*1.5	Narrow 0.5*1.5	Narrow 0.6*2.3	Narrow 0.8*2.3	Double slot 0.6*2.7*1.0	Back pressure line 3Pt0.3*0.6 1.9-2.3
0.3*2.1	0.4*1.6	0.5*1.6	0.6*2.3	0.7*2.7	0.8*3.5	1.0*5.0	1.2*7.0	Narrow 0.4*0.8	Narrow 0.5*1.6	Narrow 0.6*2.5	Narrow 0.8*2.5	Double slot 0.6*2.0*1.0	Back pressure line 3Pt0.3*0.8 1.9-2.3
	0.4*1.9	0.5*1.9	0.6*2.5	0.7*3.0	0.8*4.0	1.0*6.0	1.4*5.0	Narrow 0.4*1.0	Narrow 0.5*1.7	Narrow 0.6*2.7	Narrow 0.8*2.7	Double slot 0.6*2.3*1.0	Back pressure line 3Pt0.3*0.8 2.3-2.7
	0.4*2.0	0.5*2.1	0.6*2.7	0.7*3.2	0.8*4.5	1.0*7.0	1.4*6.0	Narrow 0.4*1.2	Narrow 0.5*1.9	Narrow 0.6*3.0		Double slot 0.6*1.9*1.0	Back pressure line 3Pt0.3*0.8 2.7-3.2
	0.4*2.3	0.5*2.3	0.6*3.0	0.7*3.5	0.8*5.0		1.4*7.0	Narrow 0.4*1.3	Narrow 0.5*2.1	Narrow 0.6*4.0		Double slot 0.6*2.5*1.0	Back pressure line 3Pt0.3*1.0 1.9-2.3
	0.4*2.5	0.5*2.5	0.6*3.2		0.8*6.0			Narrow 0.4*1.4	Narrow 0.5*2.5			Double slot 0.6*2.3*2.7	Back pressure line 4Pt0.3*0.9 2.7-3.2
	0.4*2.7	0.5*3.0	0.6*3.5					Narrow 0.4*1.5				Double slot 0.7*2.5*1.0	Back pressure line 4Pt0.3*0.9 3.5-4.0
	0.4*3.0	0.5*3.2	0.6*4.0					Narrow 0.4*1.6				Double slot 0.8*2.3*1.0	
		0.5*5.0	0.6*5.0					Narrow 0.4*1.7				Double slot 0.8*2.5*1.0	
			0.6*6.0					Narrow 0.4*2.1				Double slot 0.8*3.0*1.0	
												Double slot 0.8*3.0*2.0	

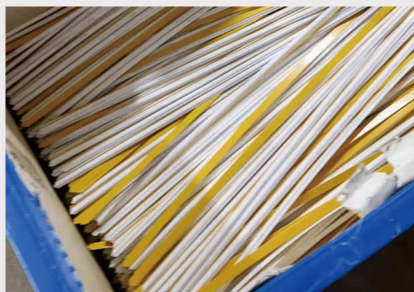

Printing Spare Part



Delivery Belt

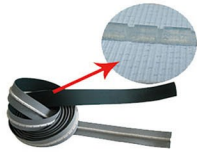

Cutter Dust Belt



Paste Box
Machine Belt



Slow Down Belt



Timing Belt



Dusting Machine
Belt



Belt



Delivery Belt



Heidelberg SM74
Slow Down Belt



Heidelberg SM74
Vacuum Feed Belt



Slow Down Belt



Synchronize Belt

Printing Machine Belt Cutter Dust Belt

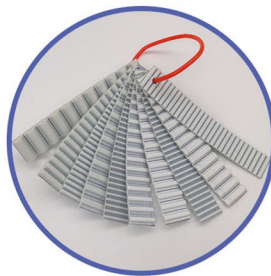
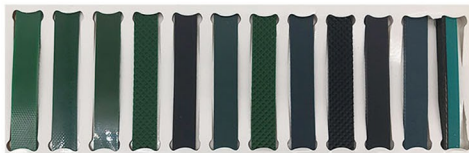

Numbering Machine

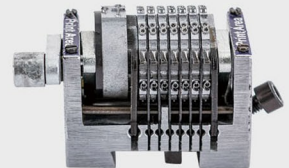
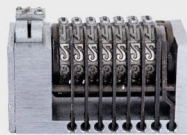
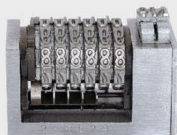

Special Regulations
Gothic / Arabic

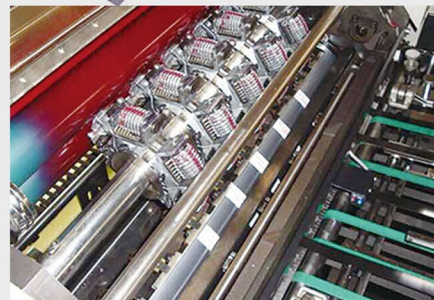
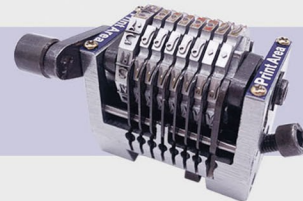

Special specifications can be customized(Font/Size/Number of digits)

Gripper Bar

All Heidelberg, Komori, Roland, Mitsubishi, Ryobi, Akiyama etc could be customized.

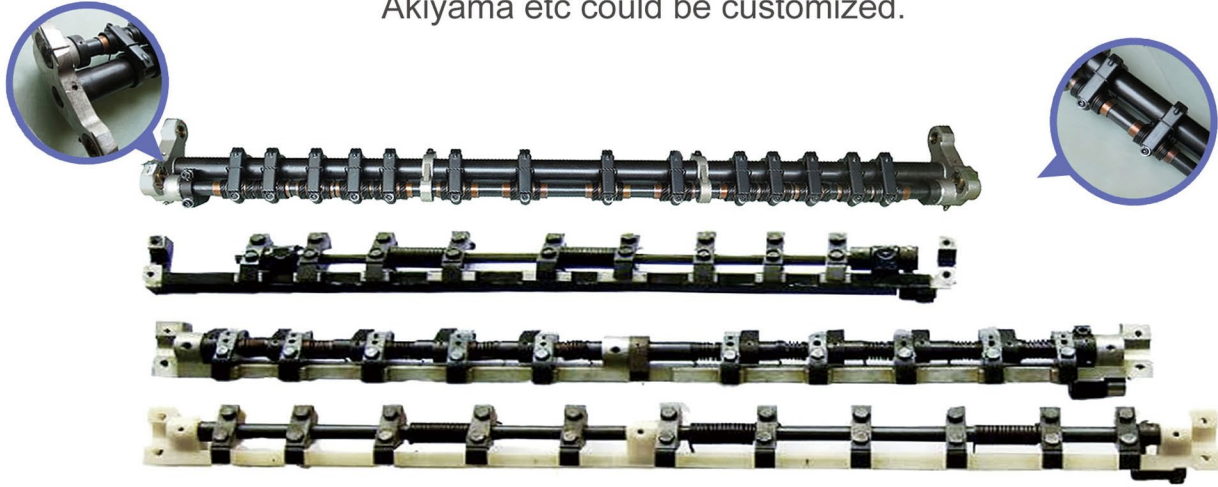

Ink Roller

All Heidelberg, Komori, Roland, Mitsubishi, Ryobi, Akiyama etc could be customized.



Brush Wheel (All the sizes can be customized.)

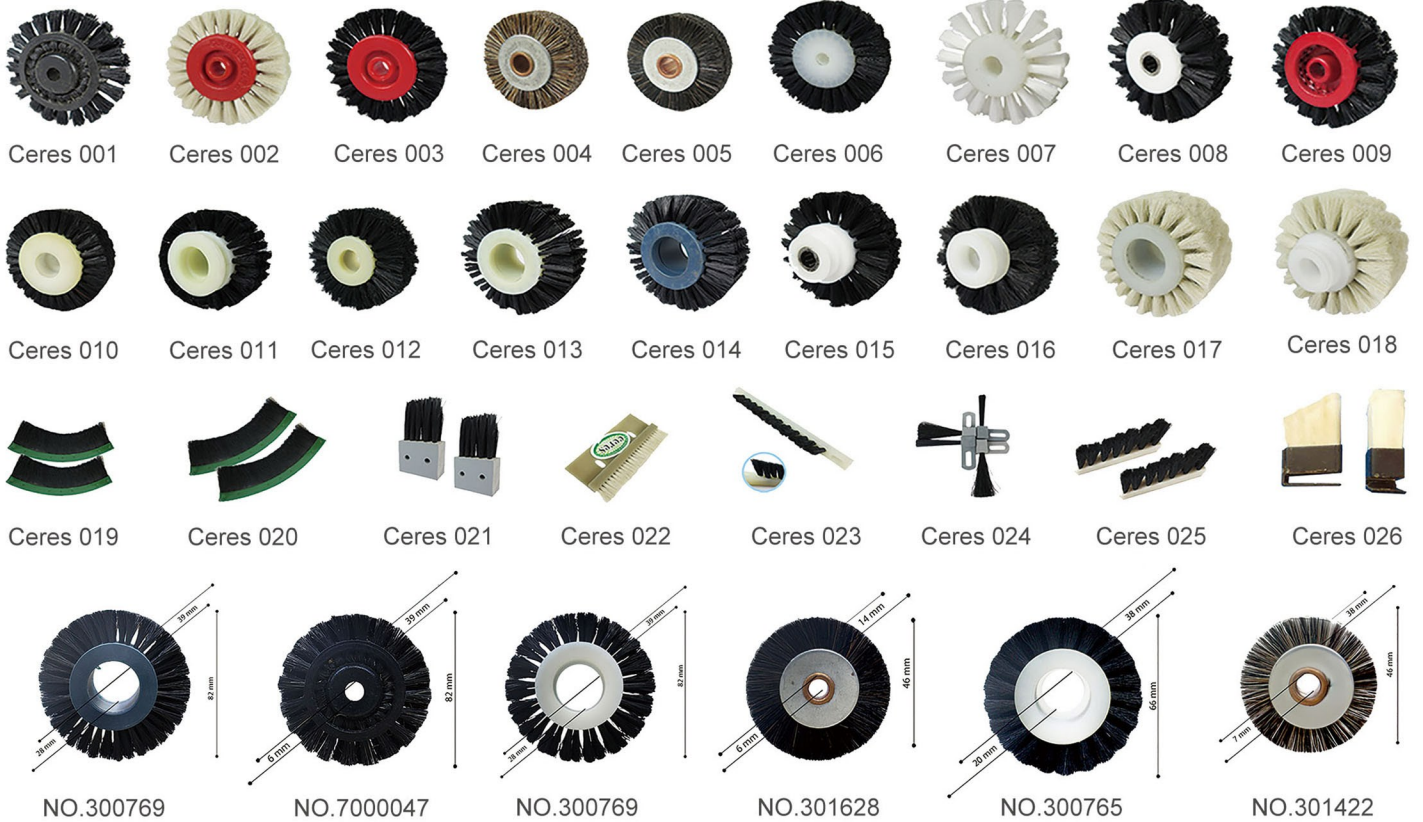

Printing Rubber Sucker (All the sizes can be customized.)



Impression Cylinder Jacket

All Heidelberg, Komori, Roland, Mitsubishi, Ryobi, Akiyama etc could be customized.



Wash Up Blades

All Heidelberg, Komori, Roland, Mitsubishi, Ryobi, Akiyama etc could be customized.

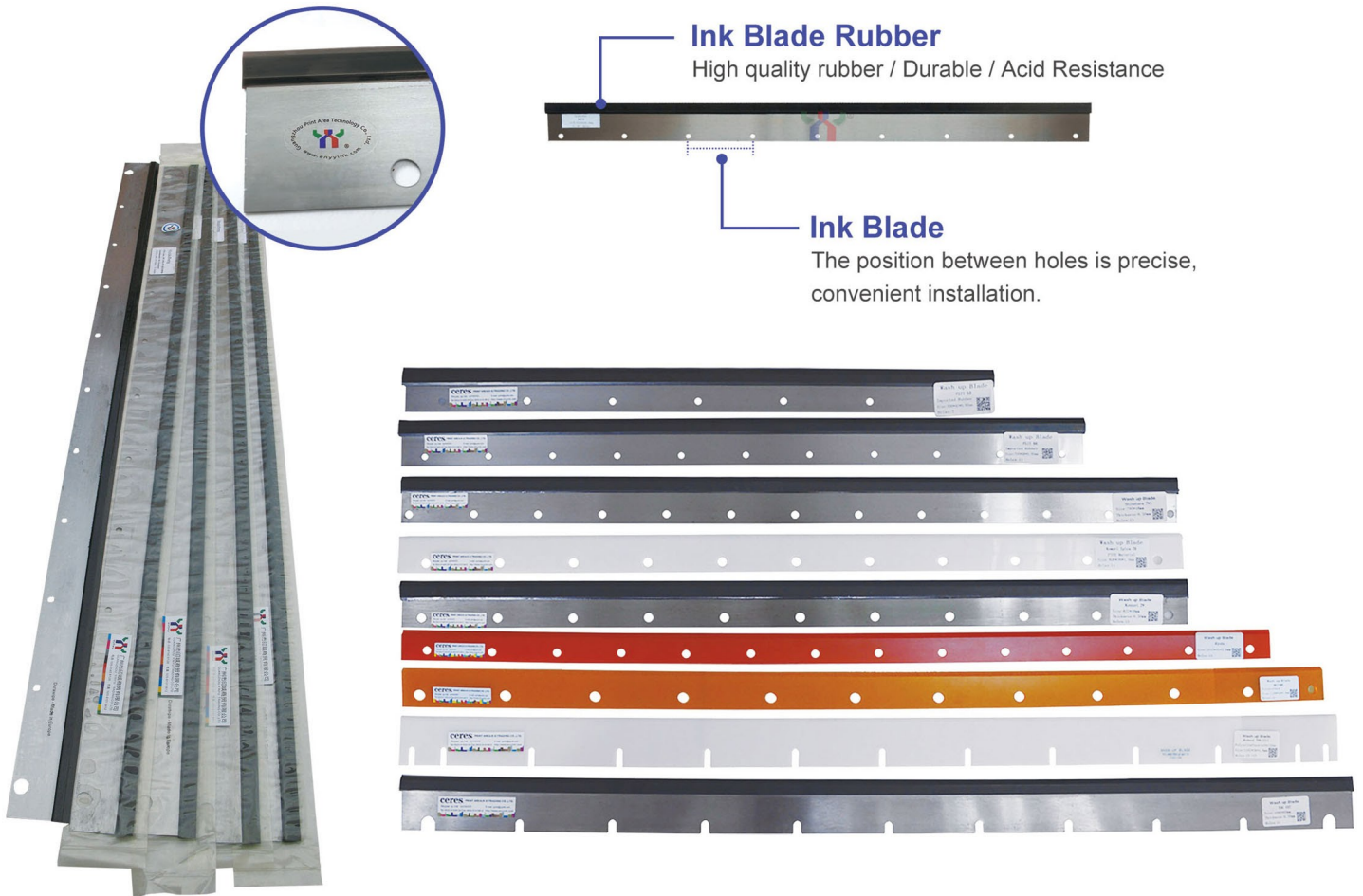

Printing Spare Part



Four color ink knife



Steel ink knife



Nylon ink knife



Ink duct end block



Paper modulator



Martini muller



Red corner block



Pig tail wrench

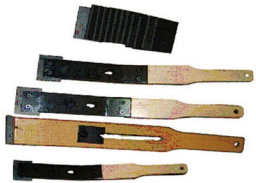

Ink hickey picker



Komori shovel



Dragon book blinding machine shifter lever



Komori paper wedge



Guide strap GTO46/Kord



Cam Follower



Gripper



Ink Motor



Paper Drill Bit



Kord 46 Gripper Pad



GTO 46 Gripper Pad



FUJI 58 Gripper Pad



CD102 Gripper Pad



Gripper Pad



Gripper Pad



Gripper Pad



Gripper Pad



Gripper Pad



Gripper Pad



Gripper Pad



Gripper Pad

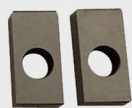

Mitsubishi 3F Gripper Pad



Gripper Pad



Spring/Retainer for Guide Strap GTO 46/52

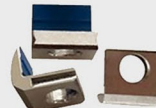

Heidelberg SM52 Gripper



Gripper Pad



Gripper Pad



Gripper Pad

Separator

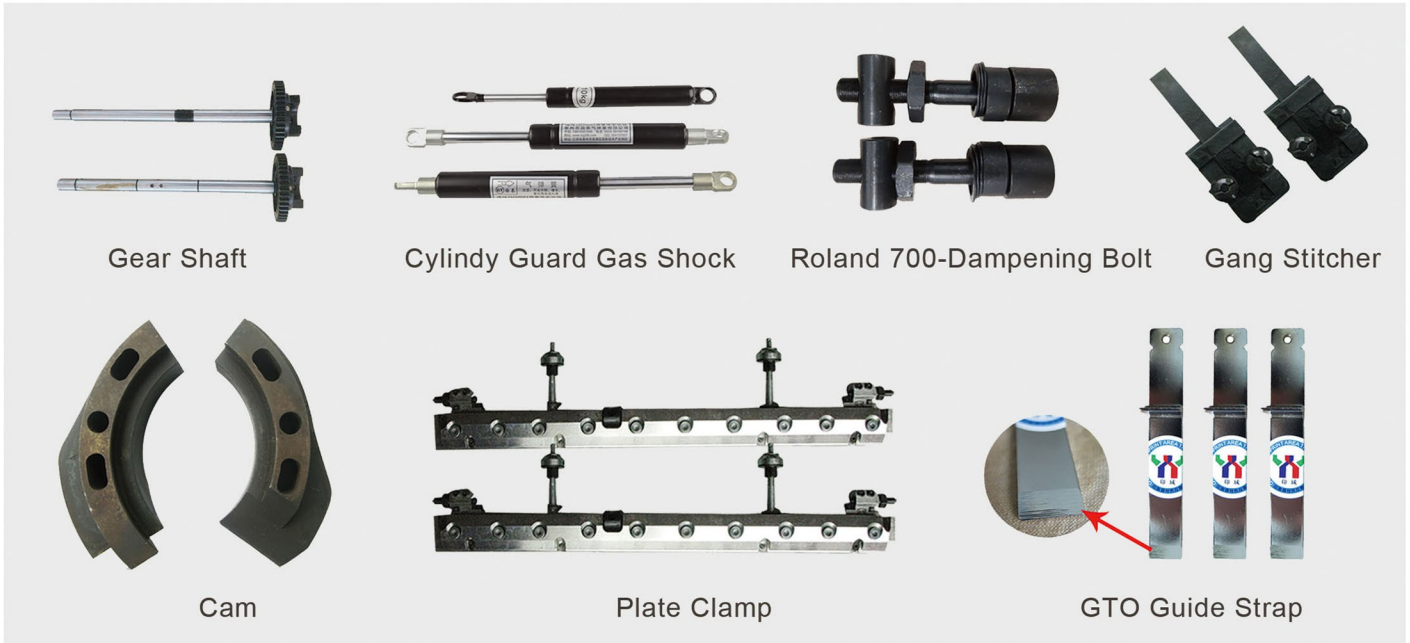

Gear Shaft

Cylindy Guard Gas Shock

Roland 700-Dampening Bolt

Gang Stitcher

Cam

Plate Clamp

GTO Guide Strap



Paper Folding Machine Lifting Sucker

Sucker Nozzle

Sucker Nozzle

Sucker Nozzle

Sucker Nozzle

KBA74 Forwarding Sucker



Heidelberg SM74 Forwarding Sucker

KBA105 Forwarding Sucker

Heidelberg SM52 Forwarding Sucker

Sucker Nozzle



Gear

Heidelberg

Water Filter Bag

KBA

Water Filter Bag

Spray Power Cup

Printing Spare Part

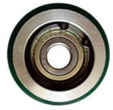

KBA72 Paper Wheel



Paper Wheel



Paper Wheel



Belt Bonder



Heidelberg Bellow



Heidelberg SM74 Fan



Fan



Heidelberg SM52
Cam Follower



Heidelberg Potentiometer



Heidelberg SM102
Air Sac Plate Clamp



Kodak CTP Plate
Making Machine Motor



Heidelberg Pressure Motor



Mitsubishi Ink
Key Motor



Shinohara 52 Motor



Latch Needle



Mitsubishi Spring



Kord Spring



Kord Spring



Torsional Spring



Front Gauge Press Gear



Roland 200 Gripper

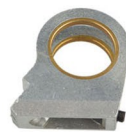

Komori Gripper Pad



Komori 26 Delivery Gripper



Gripper



Perforating Wheels



Mitsubishi Shaft



Fuji Paper Wheel Supporter



Kord Spare Part



Kord Spare Part



Heidelberg SM74
Festo Piston



Air Filter (All sizes could be customized)



Double Wire (All sizes could be customized)

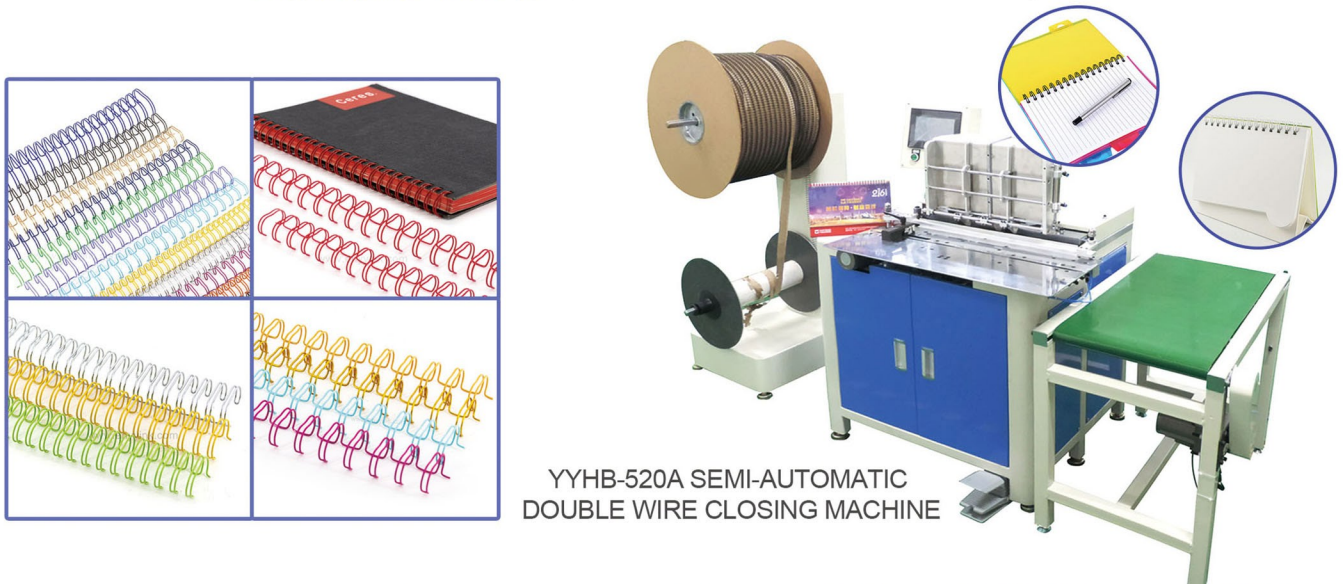

Company Profile



20+ Year Professional Experience In Printing Industry



160+ Countries Recognition



10000+ Customers Admire Our Service



One-stop Printing Materials Supplier



Our Friendship Lasts Forever





ceres® INKLOVE® EISI®

Print Area Technology Co.,Ltd

☎ +86 173 2801 1019 / +86 173 2801 8319 / +86 136 5088 7457

✉ yinya@ennyink.com / uvink@yyink.com / fluorescentink@yyink.com

☎ +86 180 2639 1301 / +86 136 5088 7457 / +86 137 2805 3627

🌐 www.ennyink.com / www.yyeisi.com / <https://www.offsetsecurityink.com>